

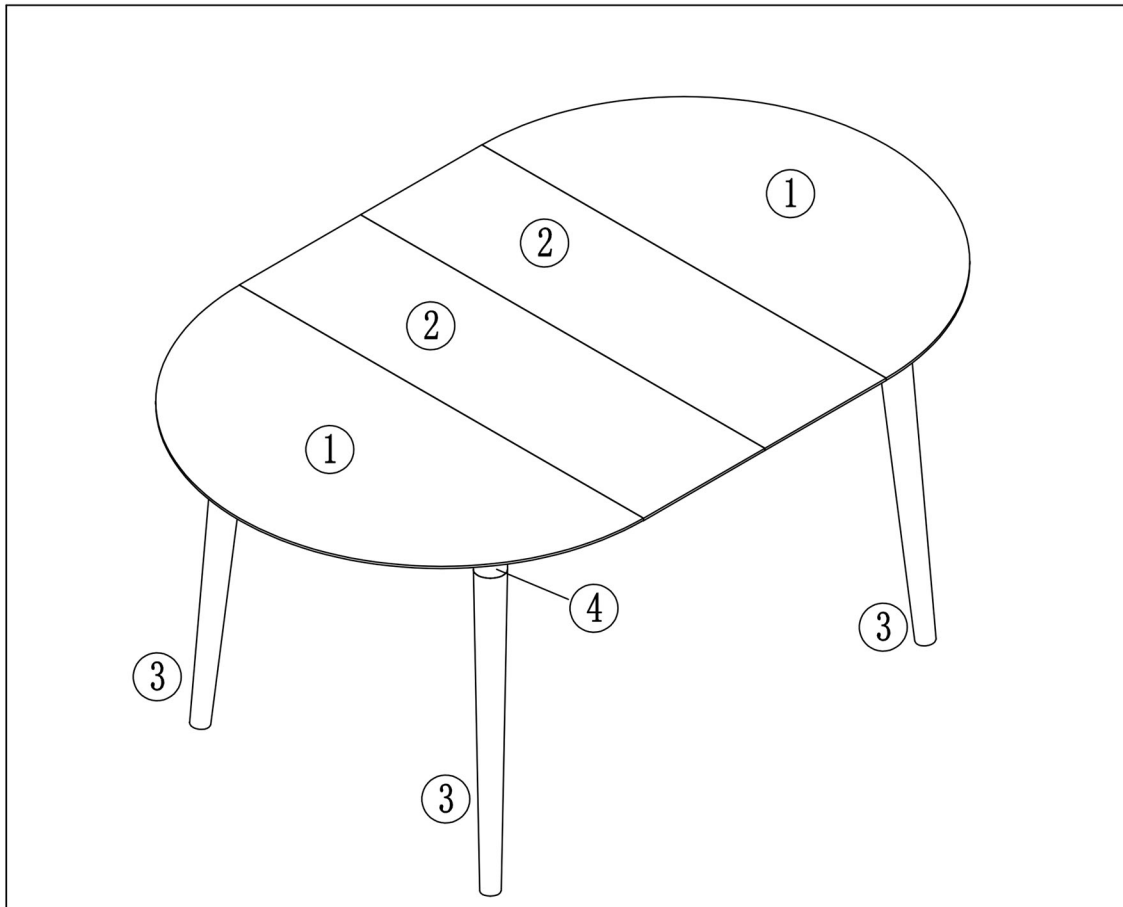





















# Instrucciones de Montaje • Assemble Instructions • Instrutions de Montange

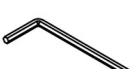
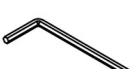

<table border="1"> <tr> <td>A</td> <td>x32</td> </tr> <tr> <td colspan="2" style="text-align: center;"></td> </tr> <tr> <td colspan="2" style="height: 20px;"></td> </tr> </table>	A	x32					<table border="1"> <tr> <td>B</td> <td>x4</td> </tr> <tr> <td colspan="2" style="text-align: center;"></td> </tr> <tr> <td colspan="2" style="height: 20px;"></td> </tr> </table>	B	x4					<table border="1"> <tr> <td>C</td> <td>x32</td> </tr> <tr> <td colspan="2" style="text-align: center;"></td> </tr> <tr> <td colspan="2" style="height: 20px;"></td> </tr> </table>	C	x32					<table border="1"> <tr> <td>D</td> <td>x4</td> </tr> <tr> <td colspan="2" style="text-align: center;"></td> </tr> <tr> <td colspan="2" style="height: 20px;"></td> </tr> </table>	D	x4				
A	x32																										
																											
B	x4																										
																											
C	x32																										
																											
D	x4																										
																											
<table border="1"> <tr> <td>E</td> <td>x6</td> </tr> <tr> <td colspan="2" style="text-align: center;"></td> </tr> <tr> <td colspan="2" style="height: 20px;"></td> </tr> </table>	E	x6					<table border="1"> <tr> <td>F</td> <td>x24</td> </tr> <tr> <td colspan="2" style="text-align: center;"></td> </tr> <tr> <td colspan="2" style="height: 20px;"></td> </tr> </table>	F	x24					<table border="1"> <tr> <td>G</td> <td>x1</td> </tr> <tr> <td colspan="2" style="text-align: center;"></td> </tr> <tr> <td colspan="2" style="height: 20px;"></td> </tr> </table>	G	x1					<table border="1"> <tr> <td>H</td> <td>x1</td> </tr> <tr> <td colspan="2" style="text-align: center;"></td> </tr> <tr> <td colspan="2" style="height: 20px;"></td> </tr> </table>	H	x1				
E	x6																										
																											
F	x24																										
																											
G	x1																										
																											
H	x1																										
																											
<table border="1"> <tr> <td>I</td> <td>x4</td> </tr> <tr> <td colspan="2" style="text-align: center;"></td> </tr> <tr> <td colspan="2" style="height: 20px;"></td> </tr> </table>	I	x4					<table border="1"> <tr> <td></td> <td></td> </tr> <tr> <td colspan="2" style="height: 20px;"></td> </tr> </table>					<table border="1"> <tr> <td></td> <td></td> </tr> <tr> <td colspan="2" style="height: 20px;"></td> </tr> </table>					<table border="1"> <tr> <td></td> <td></td> </tr> <tr> <td colspan="2" style="height: 20px;"></td> </tr> </table>										
I	x4																										
																											

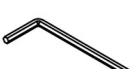
Photos and information contained in this instruction are furnished for informational use only, and are subject to change at any time without notice, and should not be construed as a commitment by us. We assume no responsibility or liability for any errors or inaccuracies that may appear in this instruction, including the products and photos described in it. Las fotos y la información contenida en esta instrucción se equipan para el uso informativo solamente, y están conforme a cambio en cualquier momento sin el aviso y no se deben interpretar como compromiso por nosotros. Nosotros no asumimos ninguna responsabilidad por ningunos errores o inexactitudes que puedan aparecer en esta instrucción, incluyendo los productos y las fotos descritos en ella.

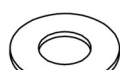
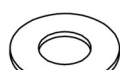
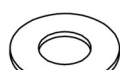
# Instrucciones de Montaje • Assemble Instructions • Instrutions de Montange

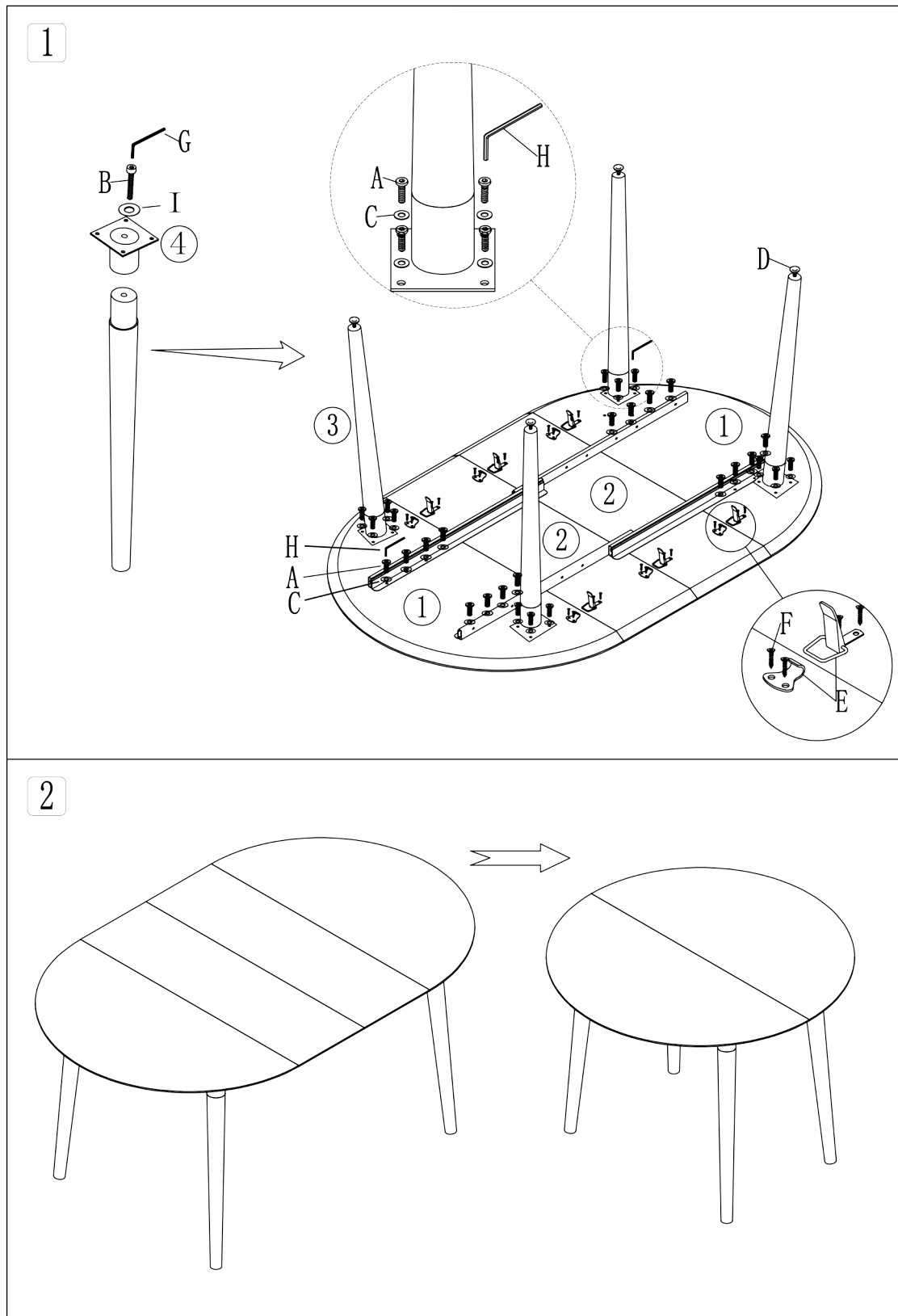

Photos and information contained in this instruction are furnished for informational use only, and are subject to change at any time without notice, and should not be construed as a commitment by us. We assume no responsibility or liability for any errors or inaccuracies that may appear in this instruction, including the products and photos described in it. Las fotos y la información contenida en esta instrucción se equipan para el uso informativo solamente, y están conforme a cambio en cualquier momento sin el aviso y no se deben interpretar como compromiso por nosotros. Nosotros no asumimos ninguna responsabilidad por ningunos errores o inexactitudes que puedan aparecer en esta instrucción, incluyendo los productos y las fotos descritos en ella.